

## C-15-155-TDFB(3)-SXX10(12)



## Features

- Duplex SC Single Mode Transceiver
- Industry Standard 1x9 Footprint
- Ultra Long reach SONET OC-3 SDH STM-1 Compliant
- Single +3.3V/+5V Power Supply
- LVPECL/PECL Differential Inputs and Outputs
- Wave Solderable and Aqueous Washable
- Class 1 Laser Int. Safety Standard IEC 825 Compliant
- Operating at 0 to 70°C
- Uncooled laser diode with MQW structure
- Complies with Telcordia (Bellcore) GR-468-CORE
- ATM 155 Mbps Links application
- SONET/SDH Equipment Interconnect application
- RoHS compliance options available

## Absolute Maximum Rating

Parameter	Symbol	Min.	Max.	Unit	Note
Power Supply Voltage	$V_{CC}$	0	3.6	V	C-15-155-TDFB3-SXX10(12)
Power Supply Voltage	$V_{CC}$	0	6	V	C-15-155-TDFB-SXX10(12)
Output Current	$I_{out}$	0	30	mA	
Soldering Temperature	-	-	260	°C	10 seconds on leads only
Operating temperature	$T_{opr}$	0	70	°C	
Storage Temperature	$T_{stg}$	-40	85	°C	

## Recommended Operating Condition

Parameter	Symbol	Min.	Typ.	Max.	Unit
Power Supply Voltage <sup>1</sup>	$V_{CC}$	3.1	3.3	3.5	V
Power Supply Voltage <sup>1</sup>	$V_{CC}$	4.75	5	5.25	V
Operating Temperature	$T_{opr}$	0	-	70	°C
Data Rate	-	-	155	-	Mbps

Note 1 : Please refer to ordering information

## C-15-155-TDFB(3)-SXX10(12)

## Transmitter Specifications

Parameter	Symbol	Min	Typical	Max	Unit	Notes
<b>Optical</b>						
Optical Transmit Power	$P_o$	-3	-	+3	dBm	C-15-155-TDFB(3)-SXX10
Optical Transmit Power	$P_o$	0	-	+5	dBm	C-15-155-TDFB(3)-SXX12
Output center Wavelength	$\lambda$	1500	1550	1600	nm	
Side Mode Suppression Ratio	Sr	30	35	-	dB	CW, $P_o = 5mW$
Output Spectrum Width	$\Delta\lambda$	-	-	1	nm	-20 dB width
Extinction Ratio	ER	8.2	-	-	dB	
Output Pulse Mask		Compliant with FDDI SMR-PMD1				
Output Eye		Compliant with ITU recommendation G.957				
Optical Rise Time	tr	-	-	2	ns	10% to 90% Values
Optical Fall Time	tf	-	-	2	ns	10% to 90% Values
Relative Intensity Noise	RIN	-	-	-116	dB/Hz	
Total Jitter	TJ	-	-	1.2	ns	

## Transmitter Specifications

Parameter	Symbol	Min	Typical	Max	Unit	Notes
<b>Electrical</b>						
Power Supply Current	$I_{CC}$	-	-	180	mA	Maximum current is specified at $V_{CC} = \text{Maximum @ maximum temperature}$
Data Input Current-Low	$I_{IL}$	-350	-	-	$\mu A$	
Data Input Current-High	$I_{IH}$	-	-	350	$\mu A$	
Differential Input Voltage	$V_{IH}-V_{IL}$	300	-	-	mV	
Data Input Voltage-Low	$V_{IL}-V_{CC}$	-2.0	-	-1.58	V	These inputs are compatible with 10K, 10KH and 100K ECL and PECL inputs
Data Input Voltage-High	$V_{IH}-V_{CC}$	-1.1	-	-0.74	V	

## C-15-155-TDFB(3)-SXX10(12)

## Receiver Specifications

Parameter	Symbol	Min	Typical	Max	Unit	Notes
<b>Optical</b>						
Sensitivity	-	-	-	-37	dBm	Measured with $2^{23}-1$ PRBS with 72 ones and 72 zeros.
Maximum Input Power	$P_{in}$	0	-	-	dBm	
Signal Detect-Asserted	$P_a$	-	-	-37	dBm	Measured on transition: low to high
Signal Detect-Deasserted	$P_d$	-47	-	-	dBm	Measured on transition: high to low
Signal Detect-Hysteresis		1.0	-	4.0	dB	
Wavelength of Operation		1100	-	1600	nm	

## Receiver Specifications

Parameter	Symbol	Min	Typical	Max	Unit	Note
<b>Electrical</b>						
Power Supply Current	$I_{CC}$	-	-	100	mA	The current excludes the output load current
Data Output Voltage-Low	$V_{OL} - V_{CC}$	-2.0	-	-1.58	V	These outputs are compatible with 10K, 10KH and 100KECL and PECL outputs
Data Output Voltage-High	$V_{OH} - V_{CC}$	-1.1	-	-0.74	V	
Signal Detect Output Voltage-Low	$V_{SDL} - V_{CC}$	-2	-	-1.58	V	
Signal Detect Output Voltage-High	$V_{SDH} - V_{CC}$	1.1	-	0.74	V	

## Connection Diagram

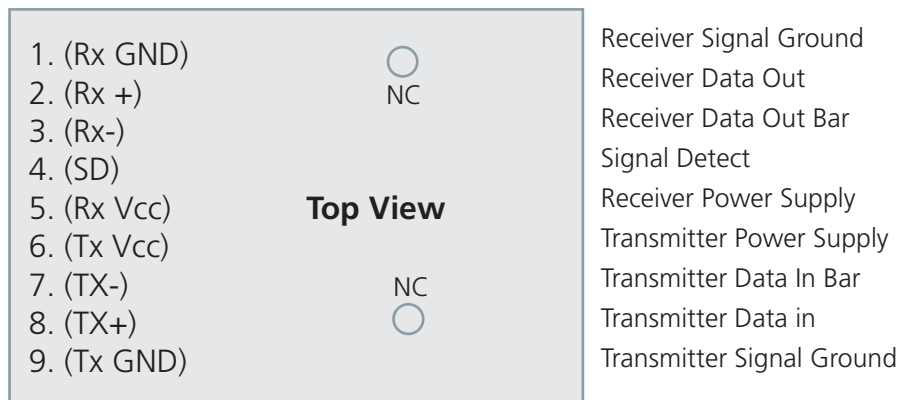

PIN	Symbol	Notes
1	RxGND	Directly connect this pin to the receiver ground plane
2	RD+	See recommended circuit schematic
3	RD-	See recommended circuit schematic
4	SD	Active high on this indicates a received optical signal
5	RxVcc	DC power for the receiver section
6	TxVcc	DC power for the transmitter section
7	TD-	See recommended circuit schematic
8	TD+	See recommended circuit schematic
9	TxGND	Directly connect this pin to the transmitter ground plane

Recommended Circuit Schematic

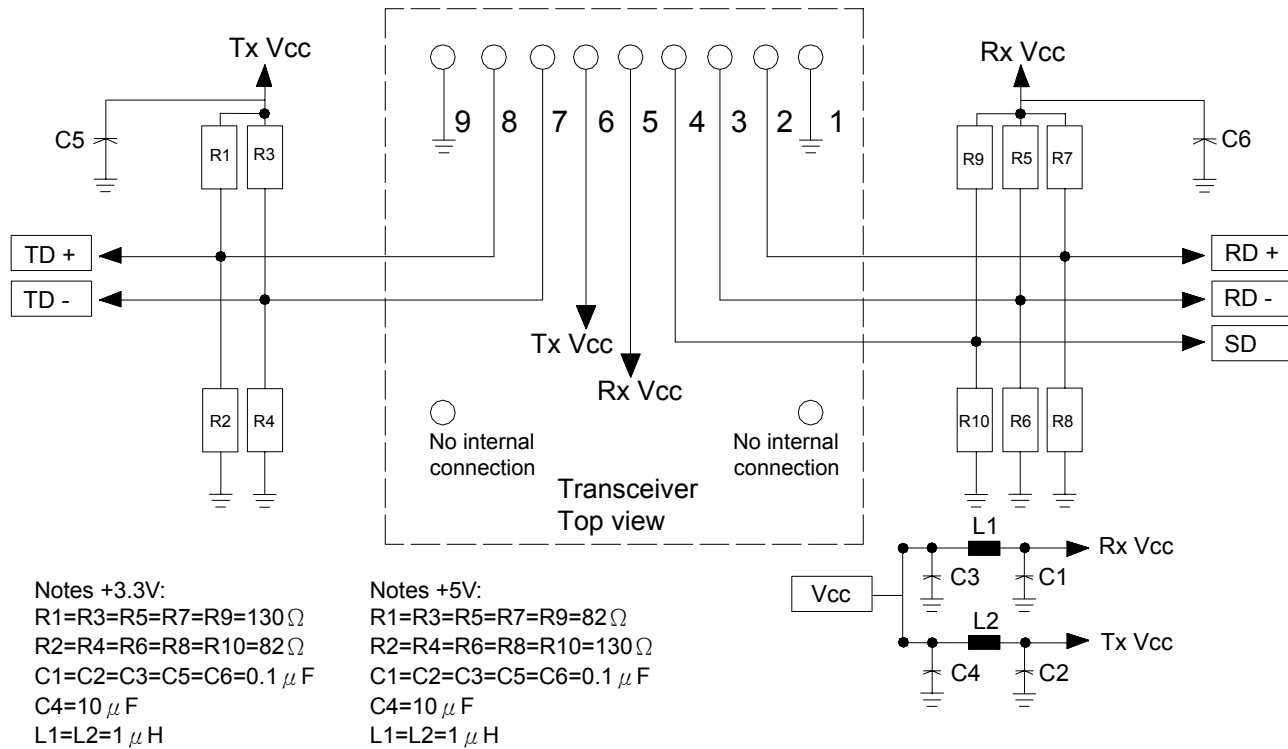

The split-loaded terminations for ECL signals need to be located at the input of devices receiving those ECL signals. The power supply filtering is required for good EMI performance. Use short tracks from the inductor L1/L2 to the module Rx Vcc. A GND plane under the module is required for good EMI and sensitivity performance.

SC Transceiver Assembly 10.4mm

Top View

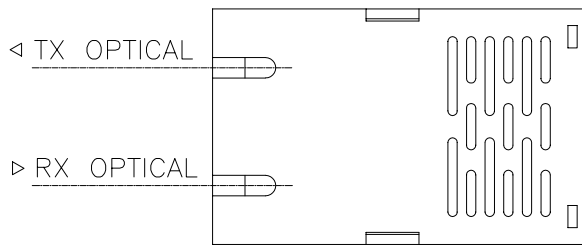

Front View

Units: mm

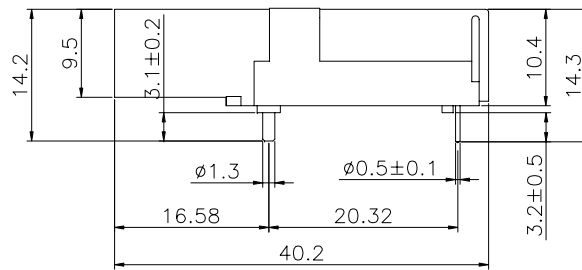
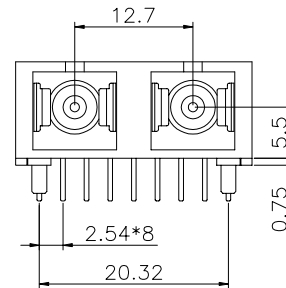

Side View

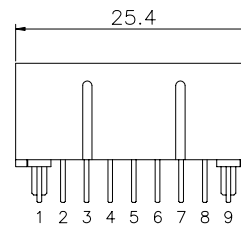

Rear View

Package Option:  
Blank = Black case

SC Transceiver Assembly 9.8mm

Top View

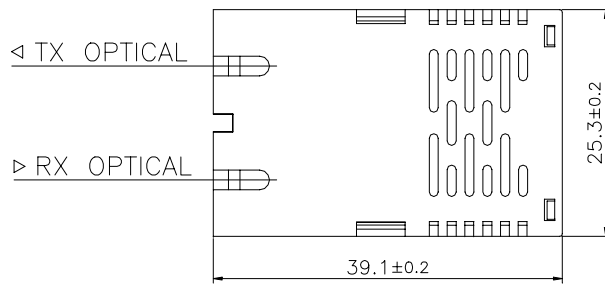

Front View

Units: mm

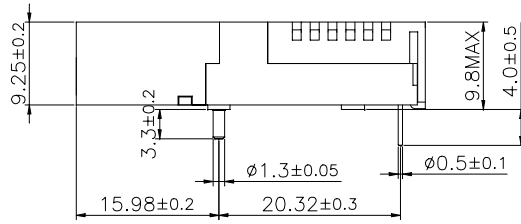
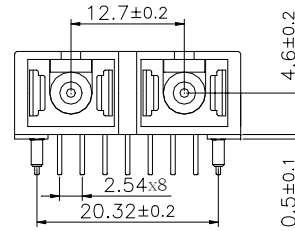

Side View

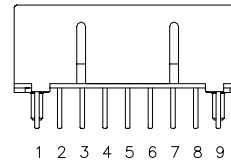

Rear View

Package Option:

D = Black case

E = Blue case

FC Transceiver Assembly

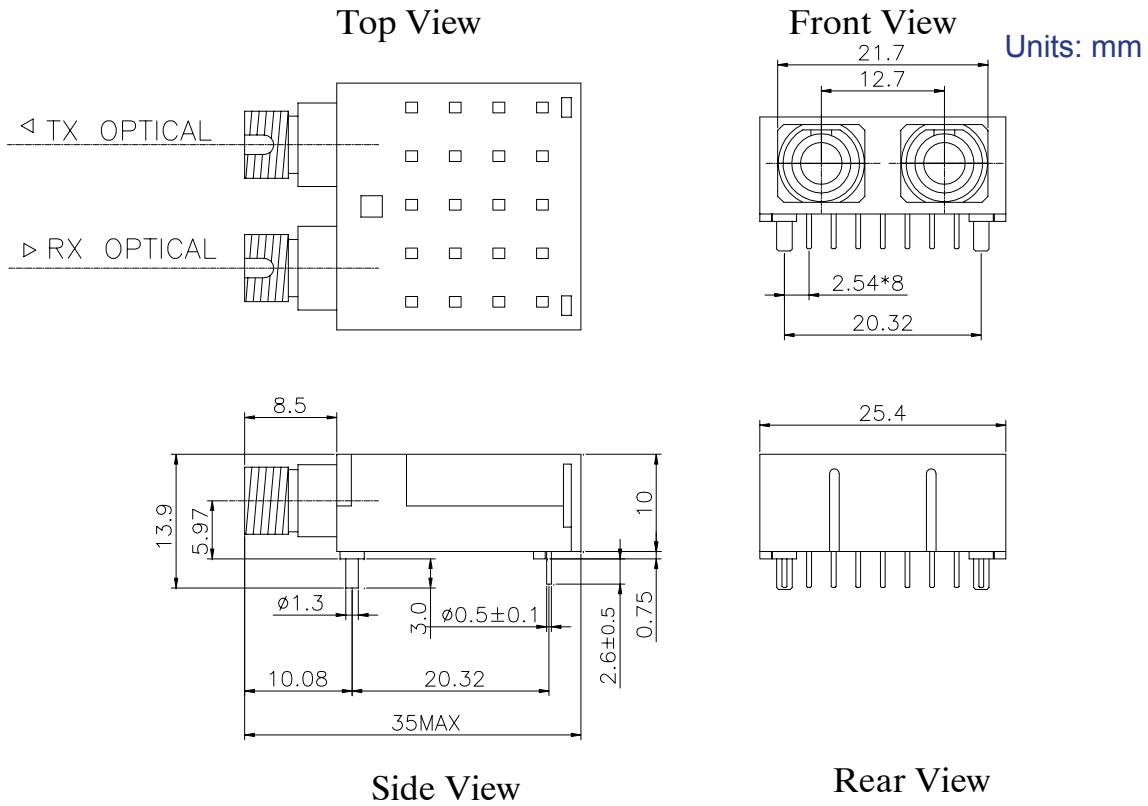



ST Transceiver Assembly

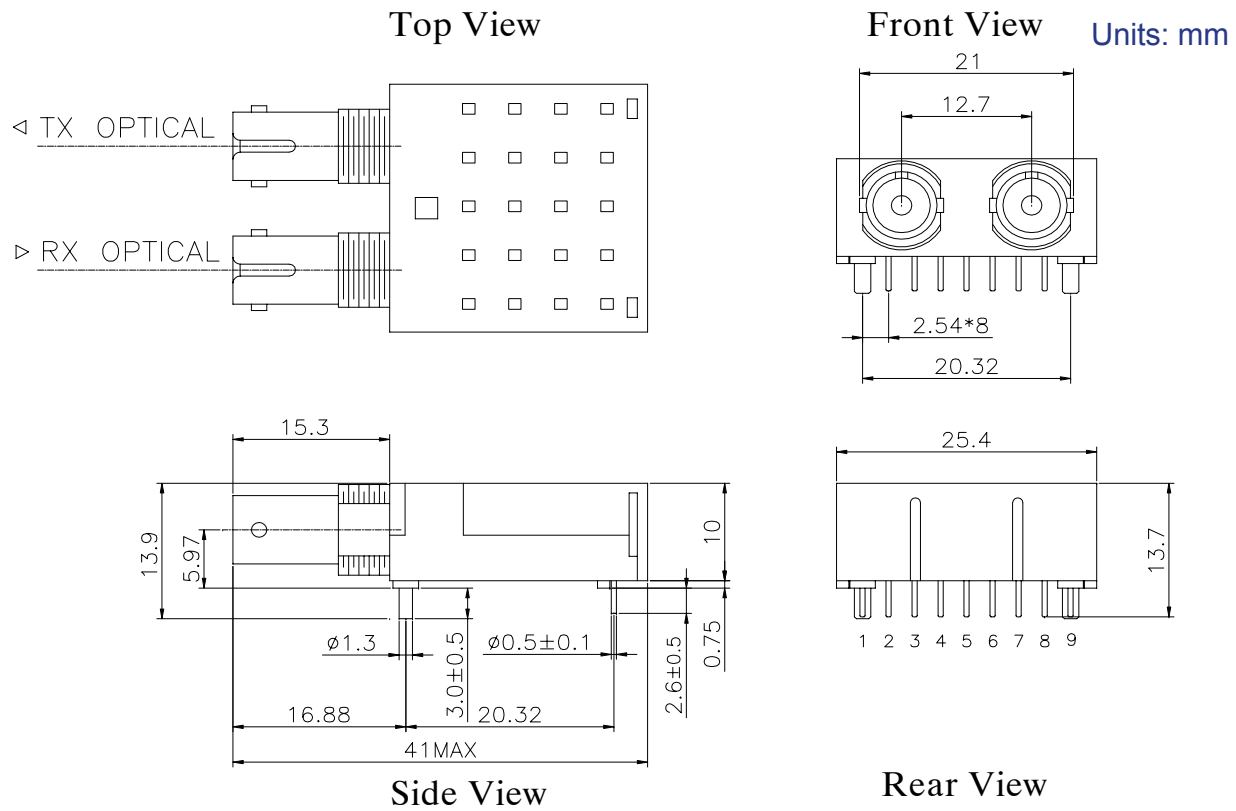

### Ordering Information

Available Options:

C-15-155-TDFB3-SSC(FC/ST)10	C-15-155-TDFB3-SSC(FC/ST)10-G5
C-15-155-TDFB-SSC(FC/ST)10	C-15-155-TDFB-SSC(FC/ST)10-G5
C-15-155-TDFB3-SSC(FC/ST)12	C-15-155-TDFB3-SSC(FC/ST)12-G5
C-15-155-TDFB-SSC(FC/ST)12	C-15-155-TDFB-SSC(FC/ST)12-G5
C-15-155-TDFB3-SSC10D	C-15-155-TDFB3-SSC10D-G5
C-15-155-TDFB-SSC10D	C-15-155-TDFB-SSC10D-G5
C-15-155-TDFB3-SSC12D	C-15-155-TDFB3-SSC12D-G5
C-15-155-TDFB-SSC12D	C-15-155-TDFB-SSC12D-G5
C-15-155-TDFB3-SSC10E	C-15-155-TDFB3-SSC10E-G5
C-15-155-TDFB-SSC10E	C-15-155-TDFB-SSC10E-G5
C-15-155-TDFB3-SSC12E	C-15-155-TDFB3-SSC12E-G5
C-15-155-TDFB-SSC12E	C-15-155-TDFB-SSC12E-G5

Part numbering Definition:

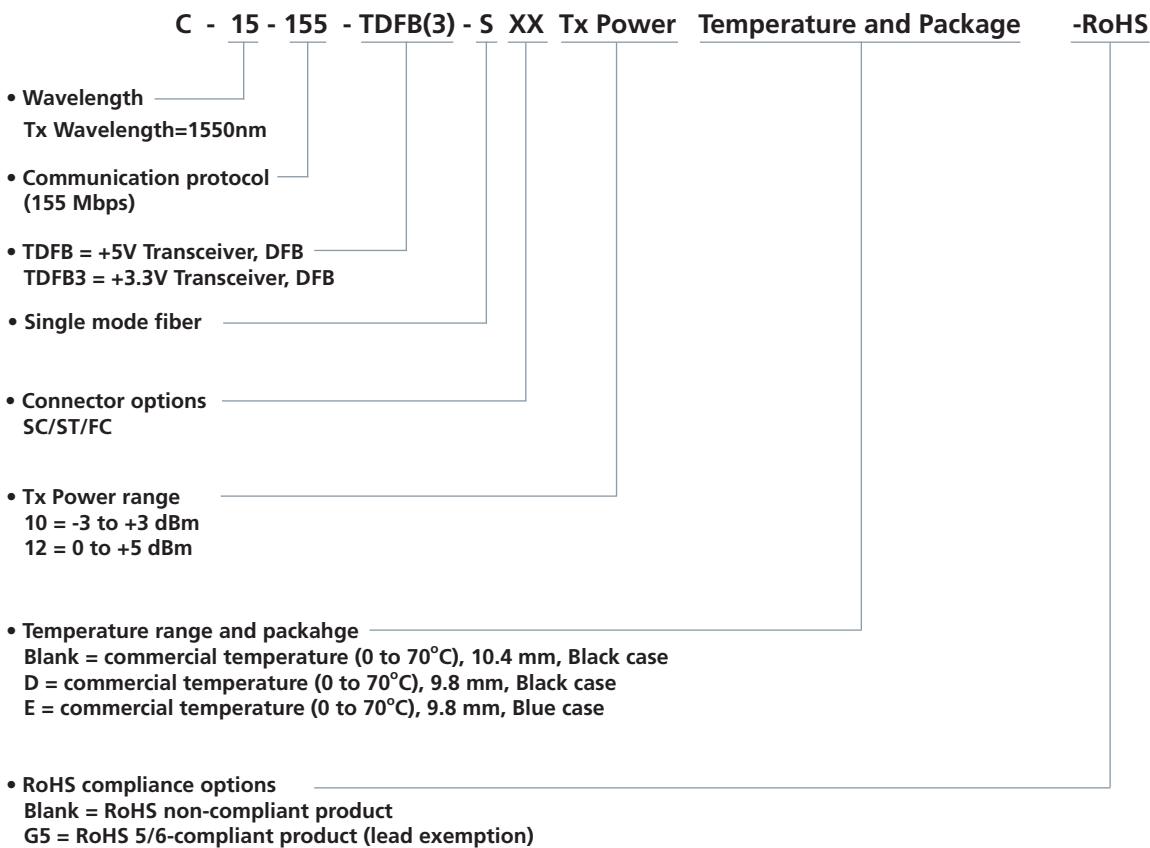

## Warnings

**Handling Precautions:** This device is susceptible to damage as a result of electrostatic discharge (ESD). A static free environment is highly recommended. Follow guidelines according to proper ESD procedures.

**Laser Safety:** Radiation emitted by laser devices can be dangerous to human eyes. Avoid eye exposure to direct or indirect radiation.

## Legal Notice

### IMPORTANT NOTICE!

All information contained in this document is subject to change without notice, at LuminentOIC's sole and absolute discretion. LuminentOIC warrants performance of its products to current specifications only in accordance with the company's standard one-year warranty; however, specifications designated as "preliminary" are given to describe components only, and LuminentOIC expressly disclaims any and all warranties for said products, including express, implied, and statutory warranties, warranties of merchantability, fitness for a particular purpose, and non-infringement of proprietary rights. Please refer to the company's Terms and Conditions of Sale for further warranty information.

LuminentOIC assumes no liability for applications assistance, customer product design, software performance, or infringement of patents, services, or intellectual property described herein. No license, either express or implied, is granted under any patent right, copyright, or intellectual property right, and LuminentOIC makes no representations or warranties that the product(s) described herein are free from patent, copyright, or intellectual property rights. Products described in this document are NOT intended for use in implantation or other life support applications where malfunction may result in injury or death to persons. LuminentOIC customers using or selling products for use in such applications do so at their own risk and agree to fully defend and indemnify LuminentOIC for any damages resulting from such use or sale.

THE INFORMATION CONTAINED IN THIS DOCUMENT IS PROVIDED ON AN "AS IS" BASIS. Customer agrees that LuminentOIC is not liable for any actual, consequential, exemplary, or other damages arising directly or indirectly from any use of the information contained in this document. Customer must contact LuminentOIC to obtain the latest version of this publication to verify, before placing any order, that the information contained herein is current.

© LuminentOIC, Inc. 2003  
All rights reserved